

edilians.com

NOS SOLUTIONS



TP

MONTAGEANLEITUNG

C-TP- 31/10/2023

Video-Tutorial: <https://youtu.be/n1d6cDNxBVo>







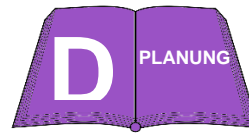
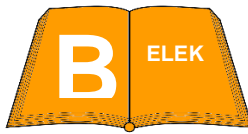



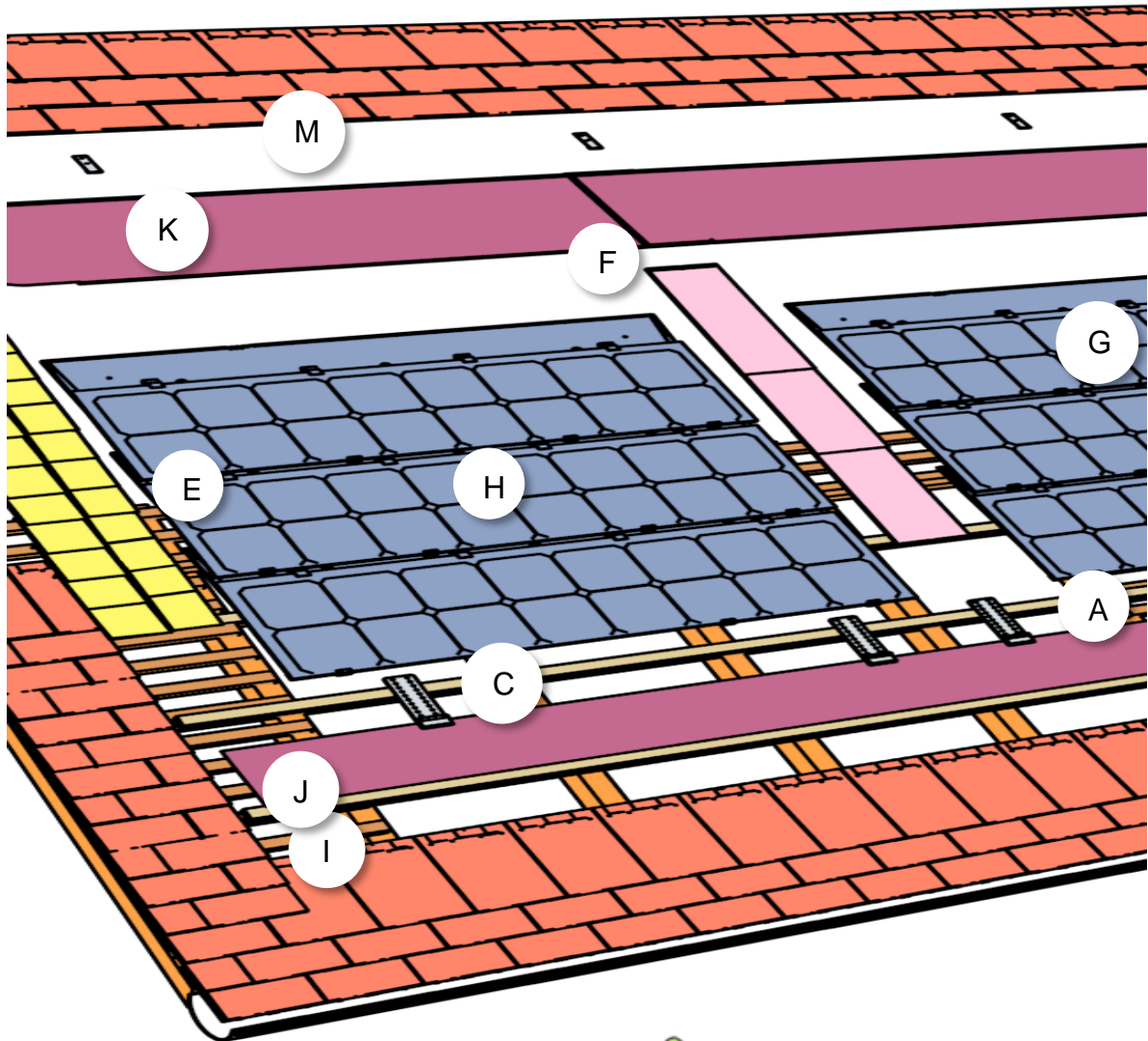

Die in der gelben Zelle enthaltenen technischen Daten gelten für den Solarziegel "TPV" – (Laminat mit 16 Zellen).

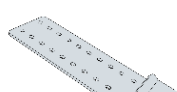
Die in der blauen Zelle enthaltenen technischen Daten gelten für den Solarziegel MAX6 "SM6"- (Laminat mit 18 Zellen).

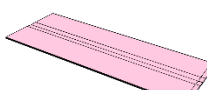

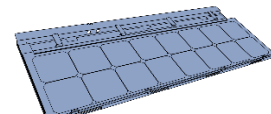
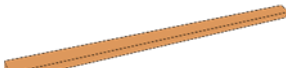
STÜCKLISTE



- | | | |
|--|--|--|
| <p>A  Unteres Bereich- Abweiserblech</p> | <p>B  Erdungskabel/ Steckverteiler</p> | <p>C  Traufhaken</p> |
| <p>D  DC-Stecker</p> | <p>E  Linkes Abdeckblech</p> | <p>F  Mittlere Rinne</p> |
| <p>G  Rechtes Abdeckblech</p> | <p>H  Solardachziegel</p> | <p>I  Mit der Dachlatte identische Latte</p> |
| <p>J  Latte 20 x 40</p> | <p>K  Starres Abweiserblech</p> | <p>M  Klammer</p> |

1. SOLARLATTEN ANBRINGEN

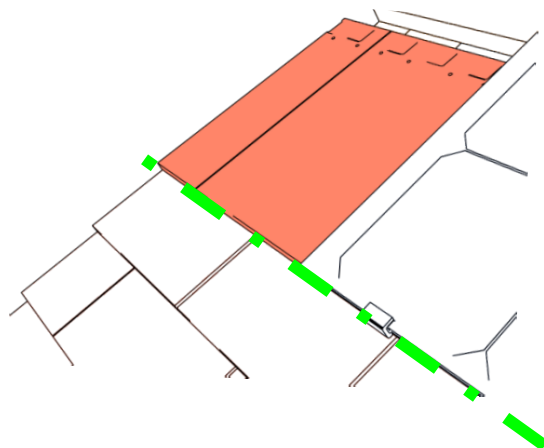
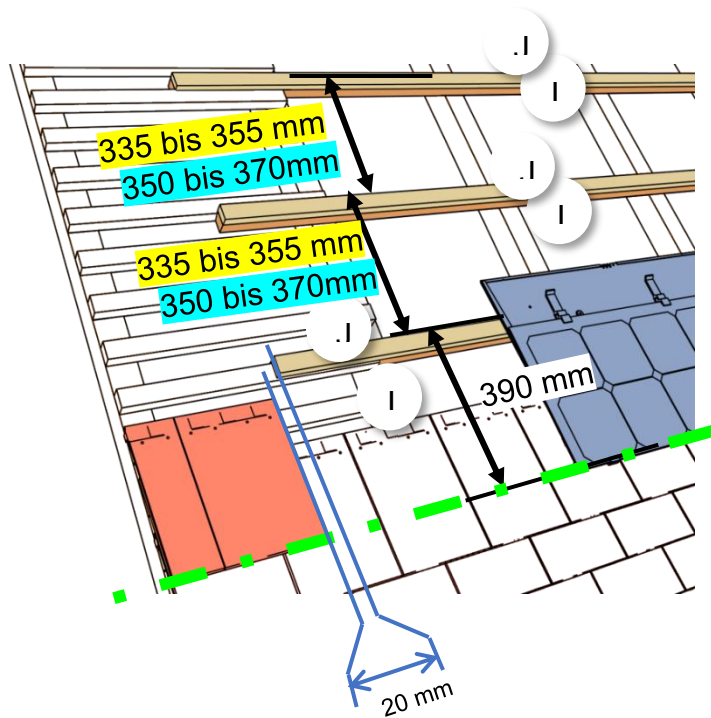
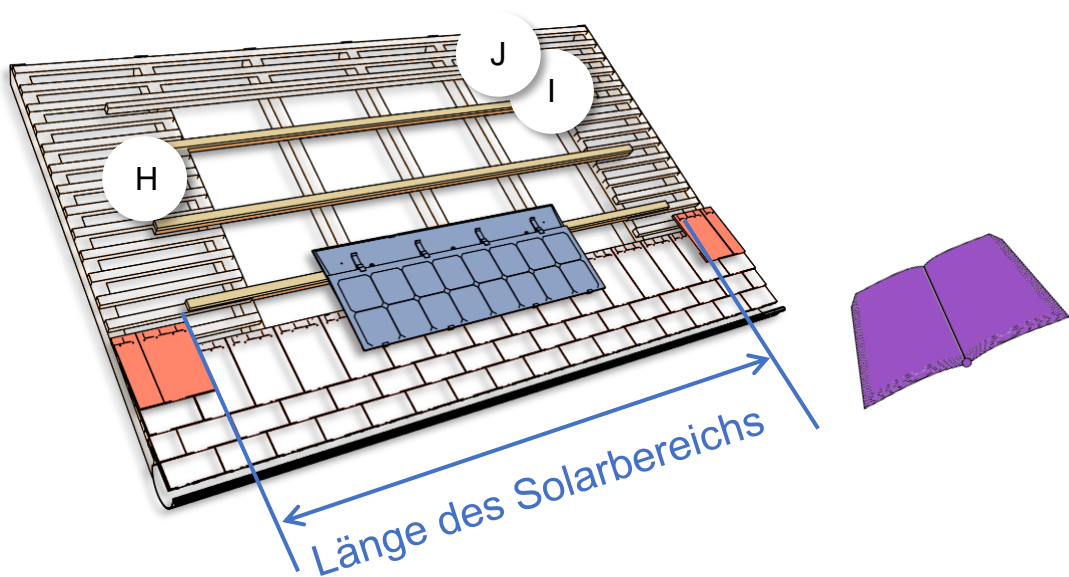

2. UNTERES ABWEISERBLECH UND TRAUFHAKEN BEFESTIGEN

1. Fall: Montage an der Traufe

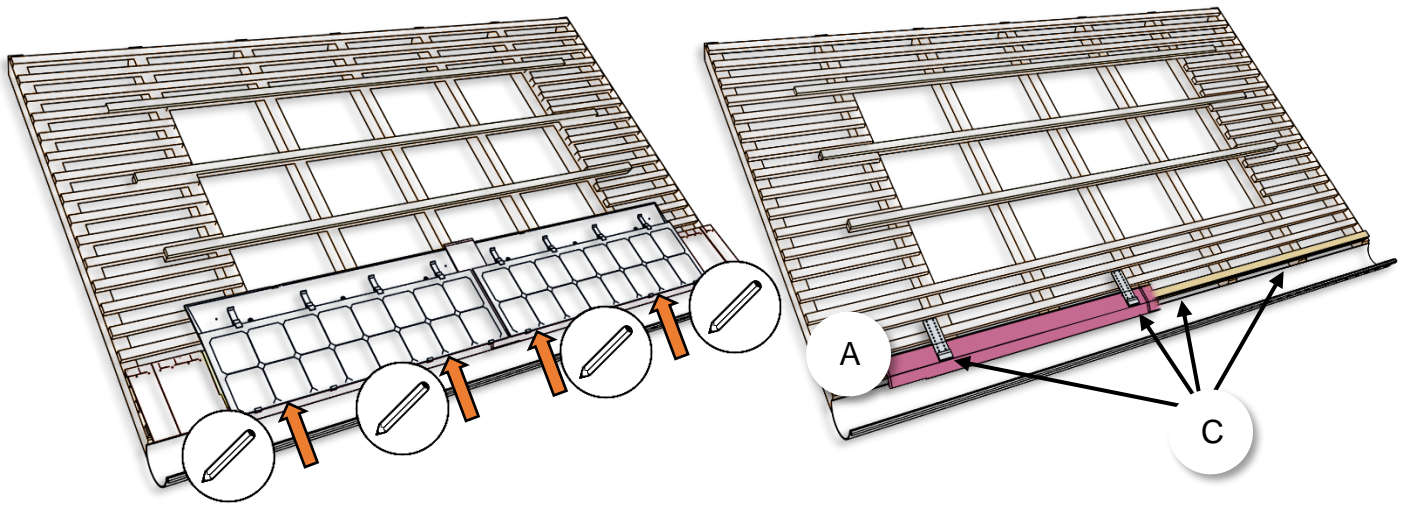

Die Unterkante des Solarbereichs an das Dach anlegen, die Eindeckungsprodukte an beiden Enden positionieren und die Position der Traufhaken gegenüber den Aussparungen rechts und links vom Rahmen markieren. Traufe auf die Eindeckungsprodukte ausgerichtet.

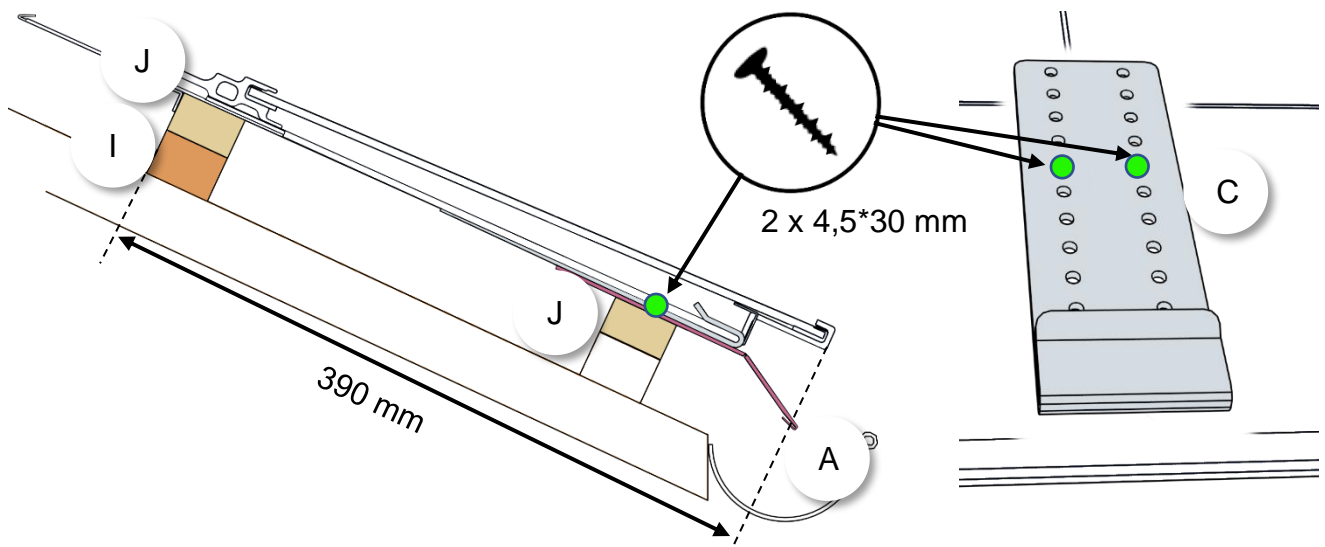
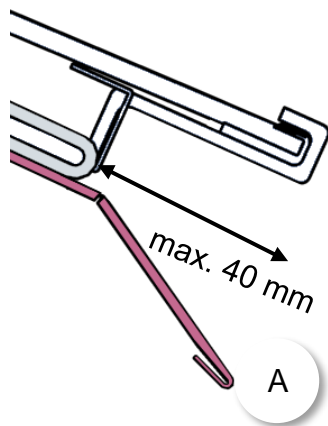

2. Fall: Montage auf dem quadratischen Grund

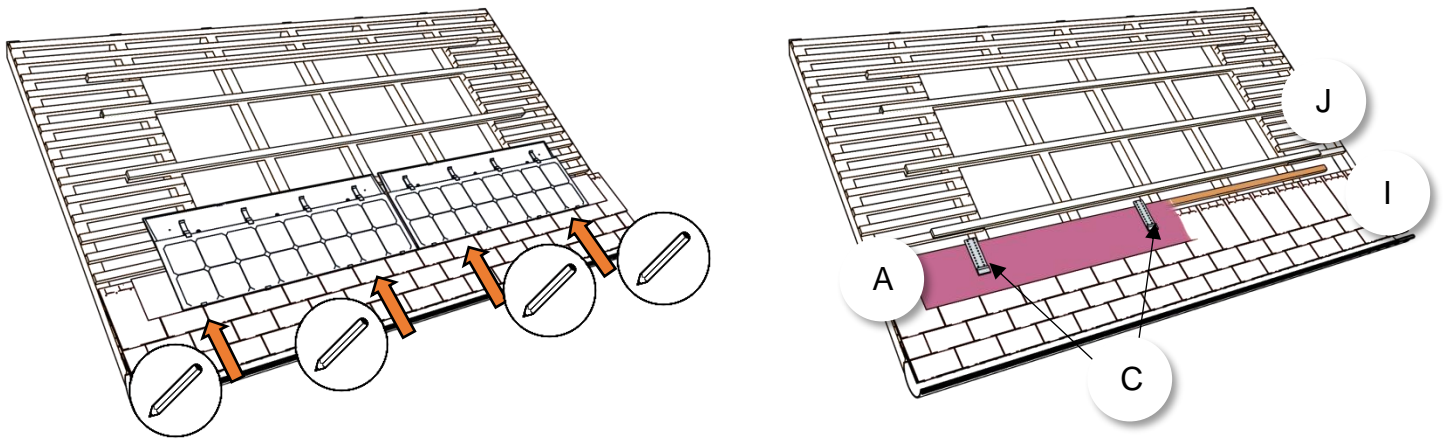

Max. Abstand zwischen 2 Säulen: 50 mm von Panel zu Panel

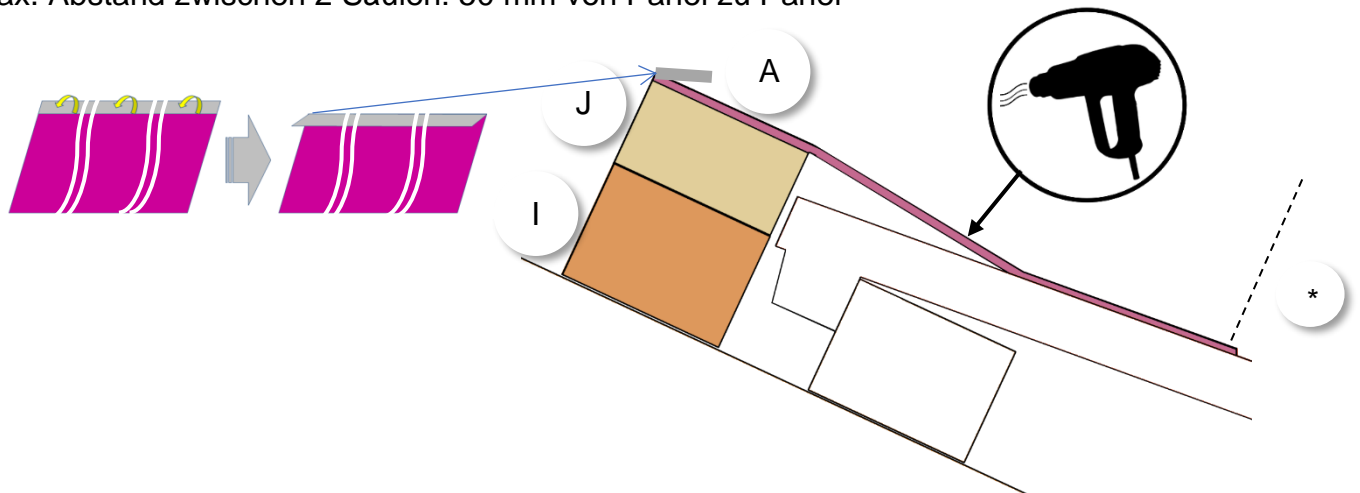

Die Unterkante des Solarbereichs an das Dach anlegen, die Eindeckungsprodukte an beiden Enden positionieren und die Position der Traufhaken gegenüber den Aussparungen rechts und links vom Rahmen markieren. *Traufe auf die Eindeckungsprodukte ausgerichtet

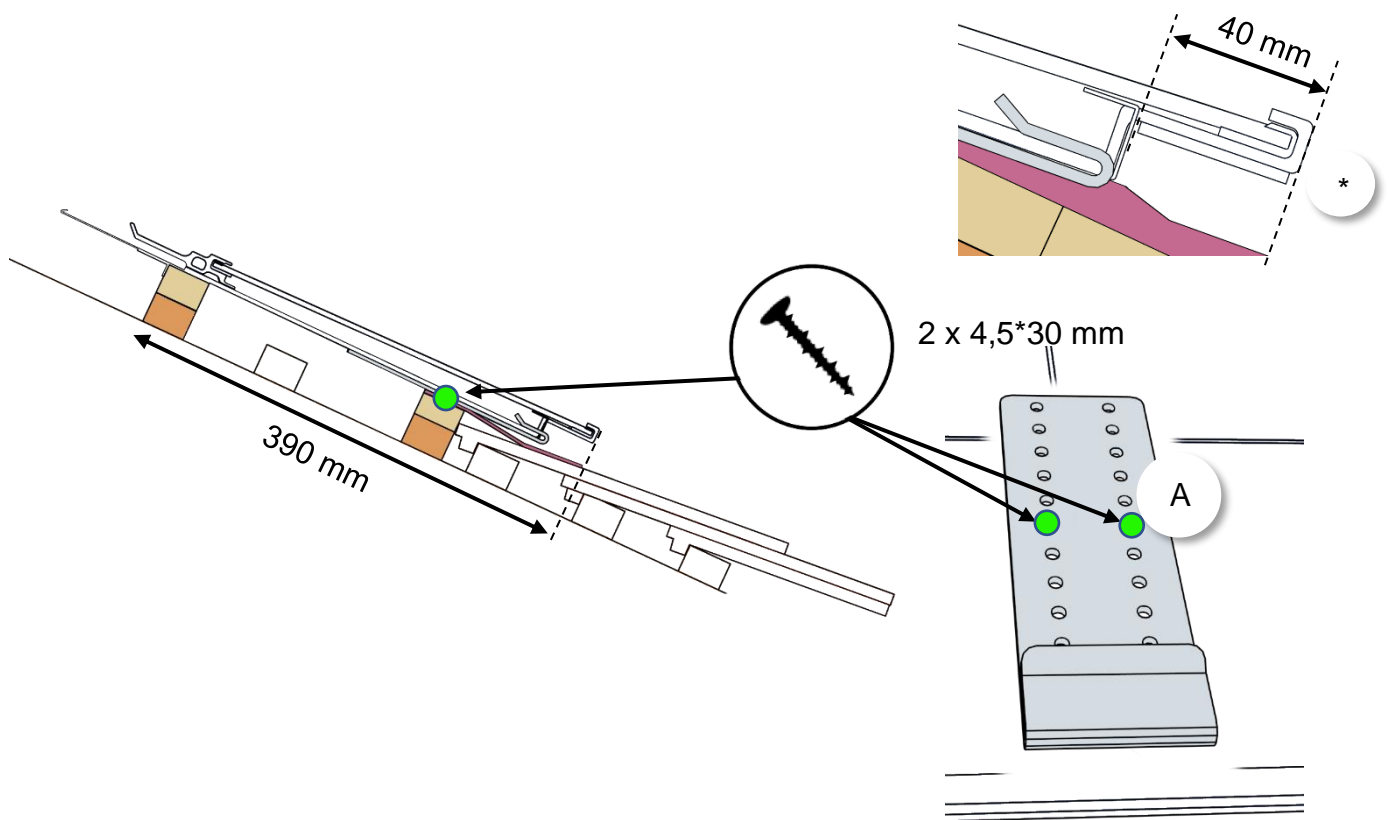

3. ERSTE REIHE SOLARDACHZIEGEL VERLEGEN

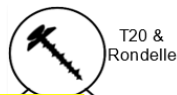
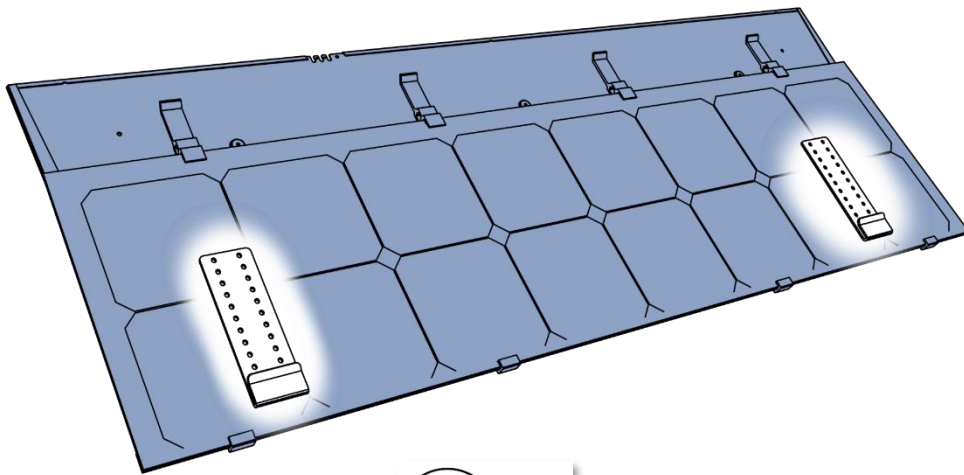
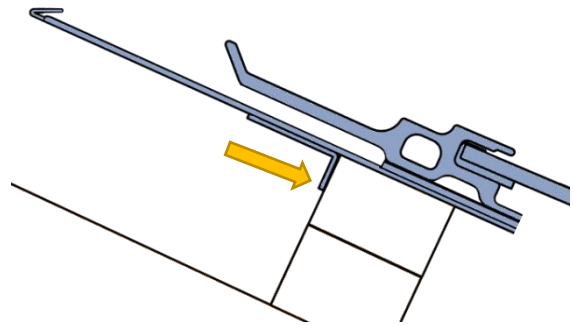
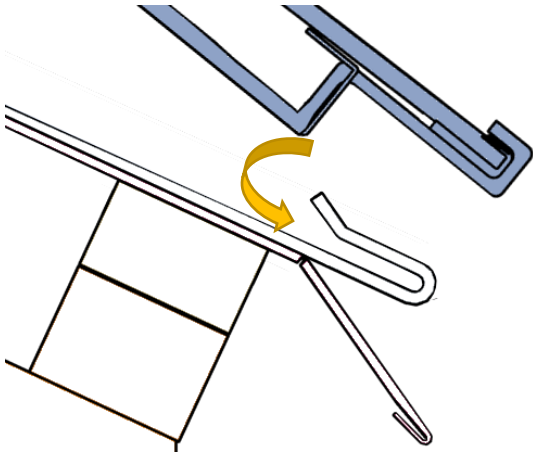
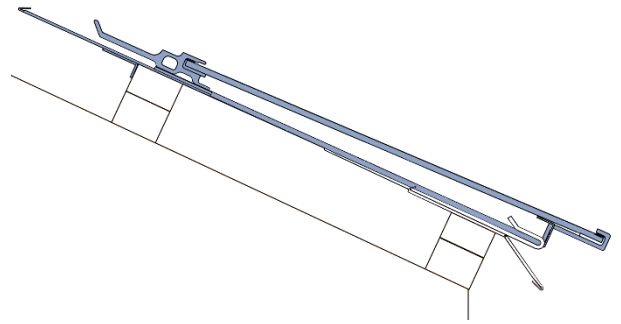
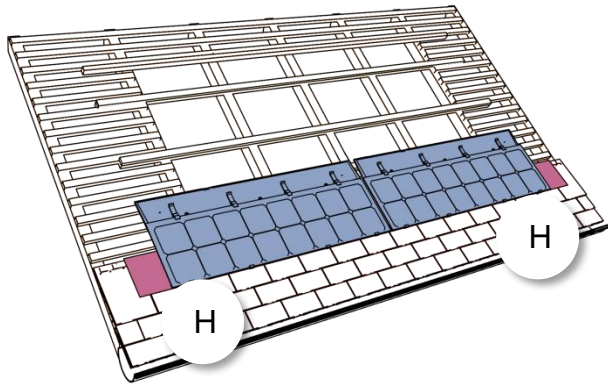

3 VIS par Ardoise PV .

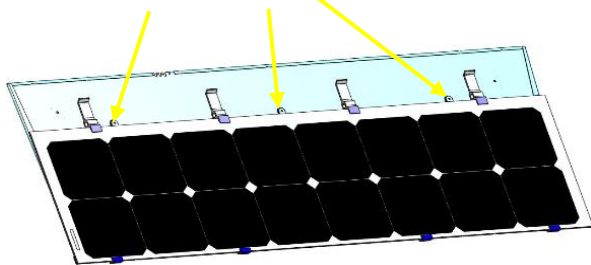

4 VIS par Ardoise SM6 .

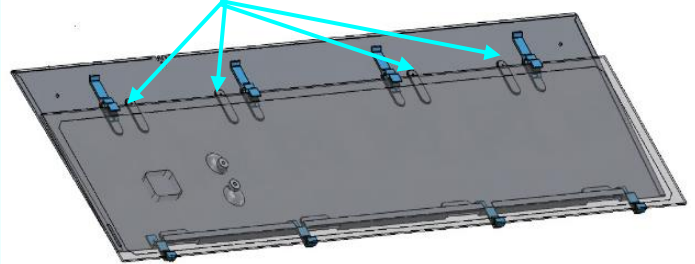

4. ERSTE SEITLICHE RINNEN JUSTIEREN

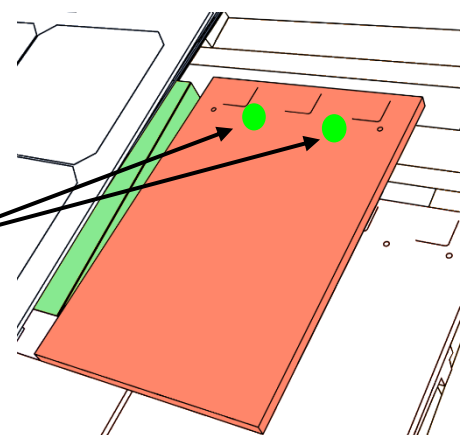
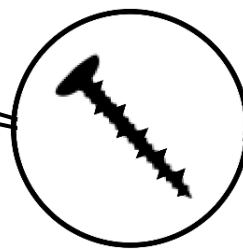
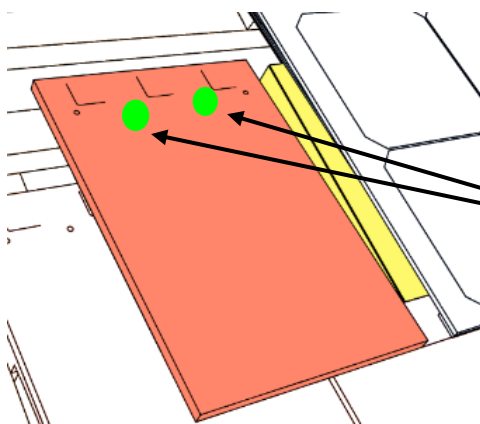
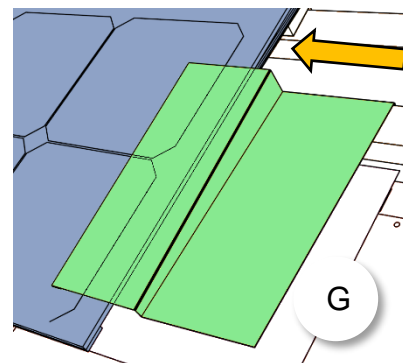
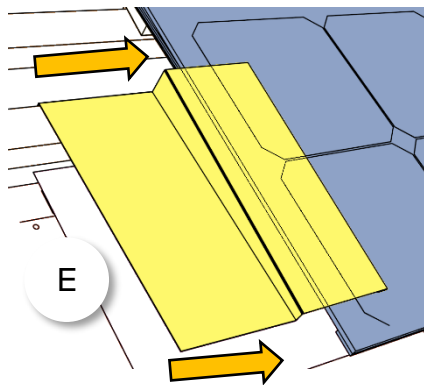
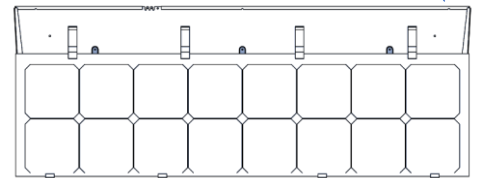
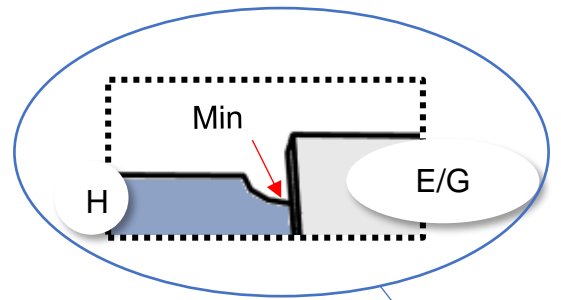
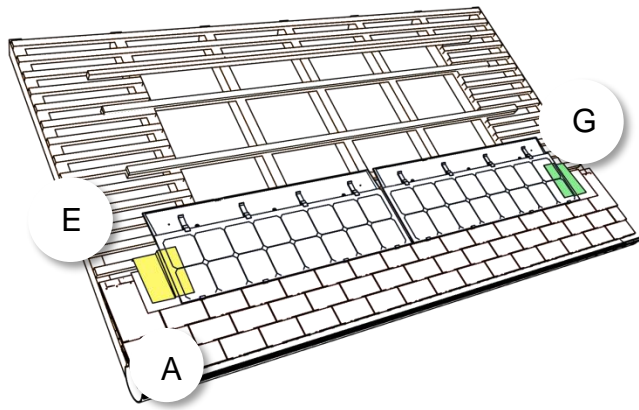

5. VERLÄNGERUNGSKABEL VERLEGEN

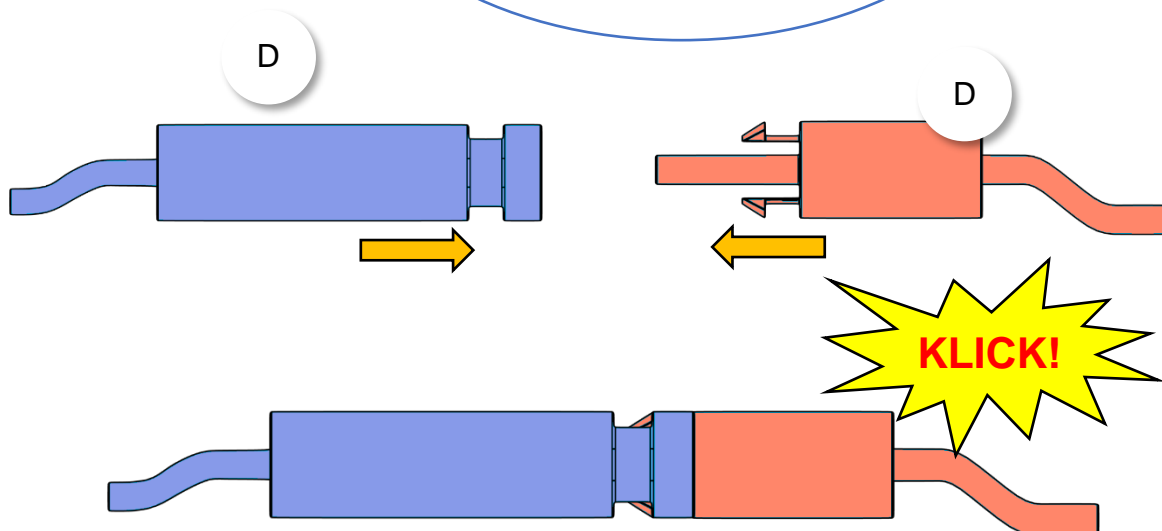
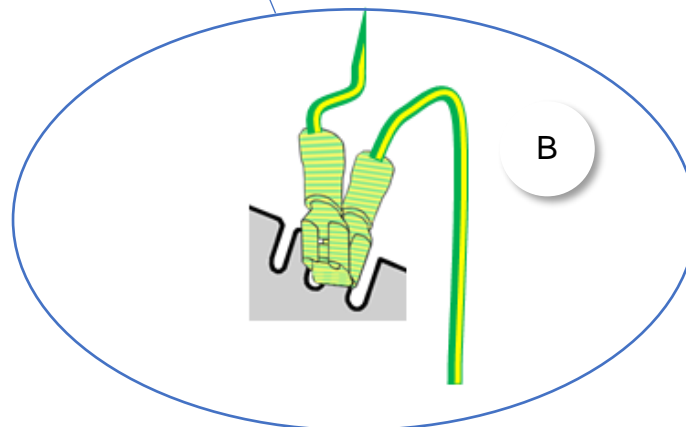
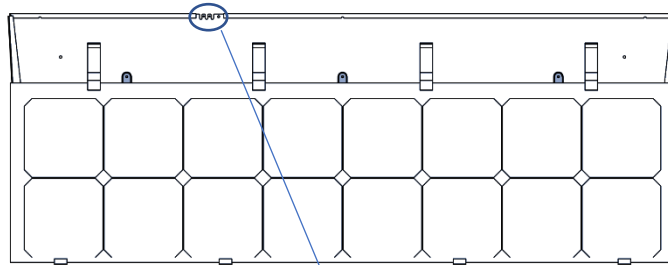
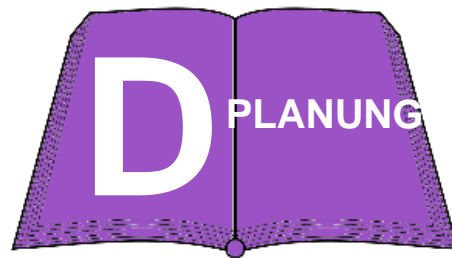
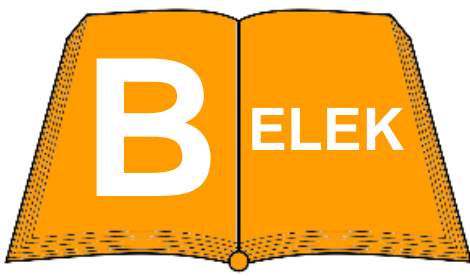

Die Verlängerungen vor dem Verlegen der zweiten Reihe einziehen

6. WEITERE REIHEN VERLEGEN

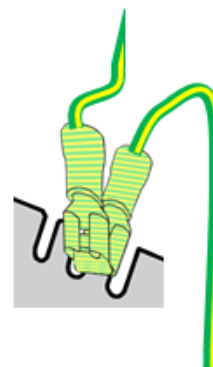
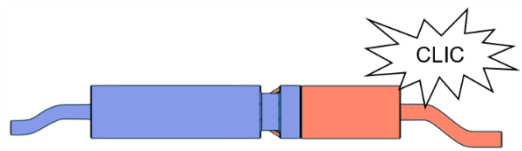
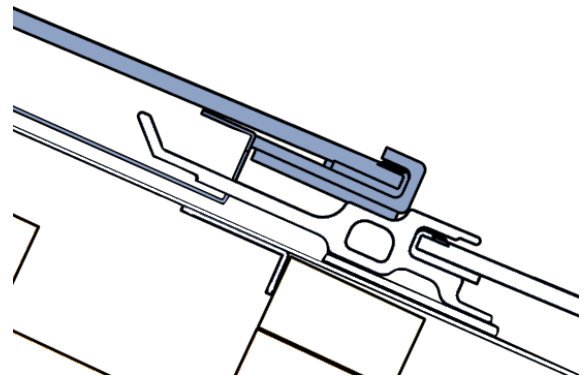
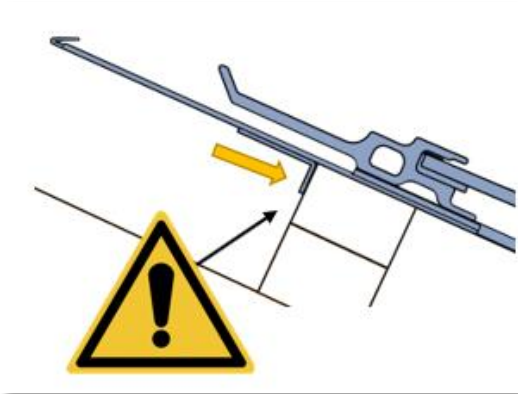
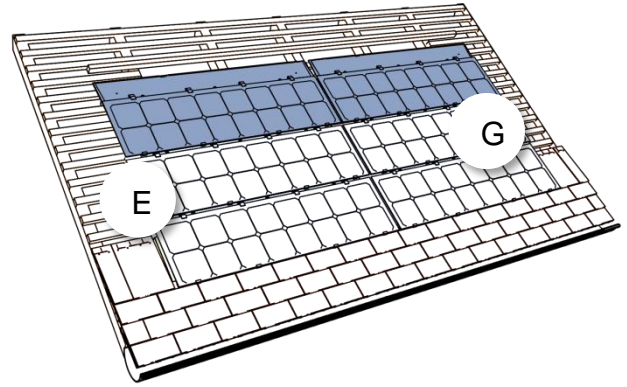
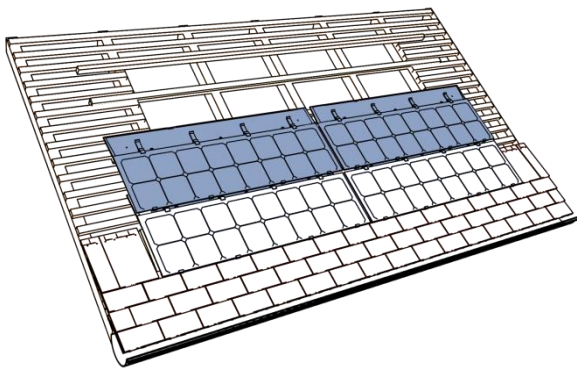

3 VIS par Ardoise PV .

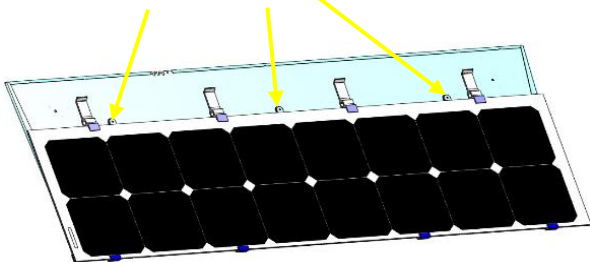

4 VIS par Ardoise SM6 .

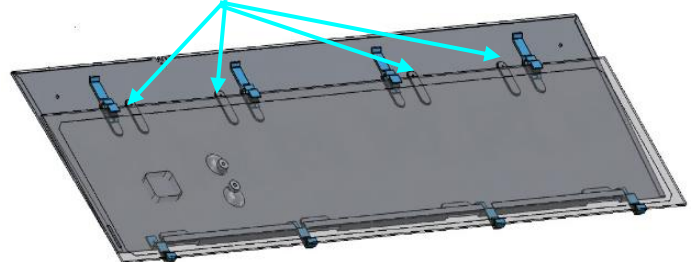

Diese Arbeitsschritte bei jeder weiteren Reihe wiederholen

7. BLECHEINFASSUNGEN VERLEGEN

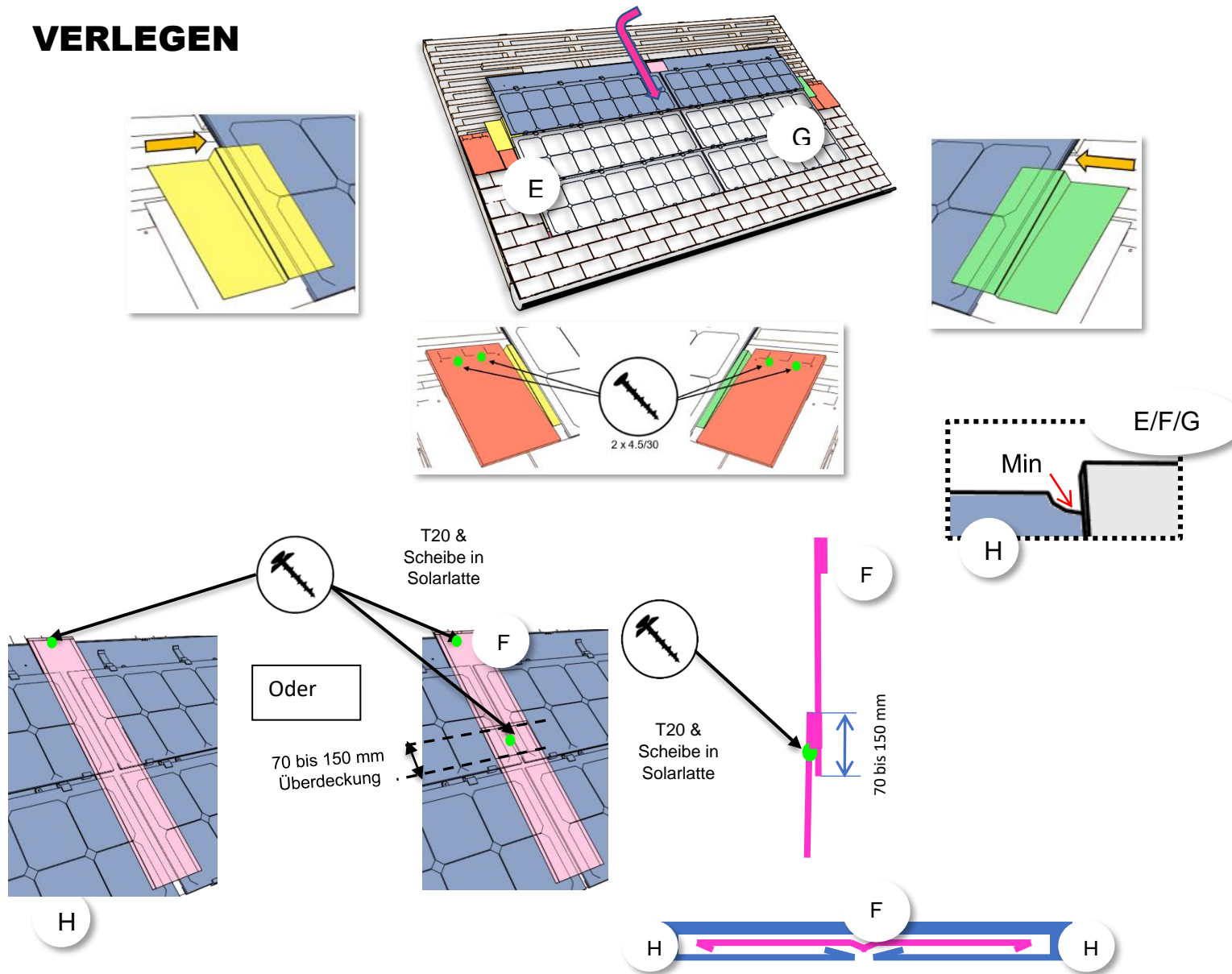

8. OBERE SEITLICHE ABDECKBLECHE

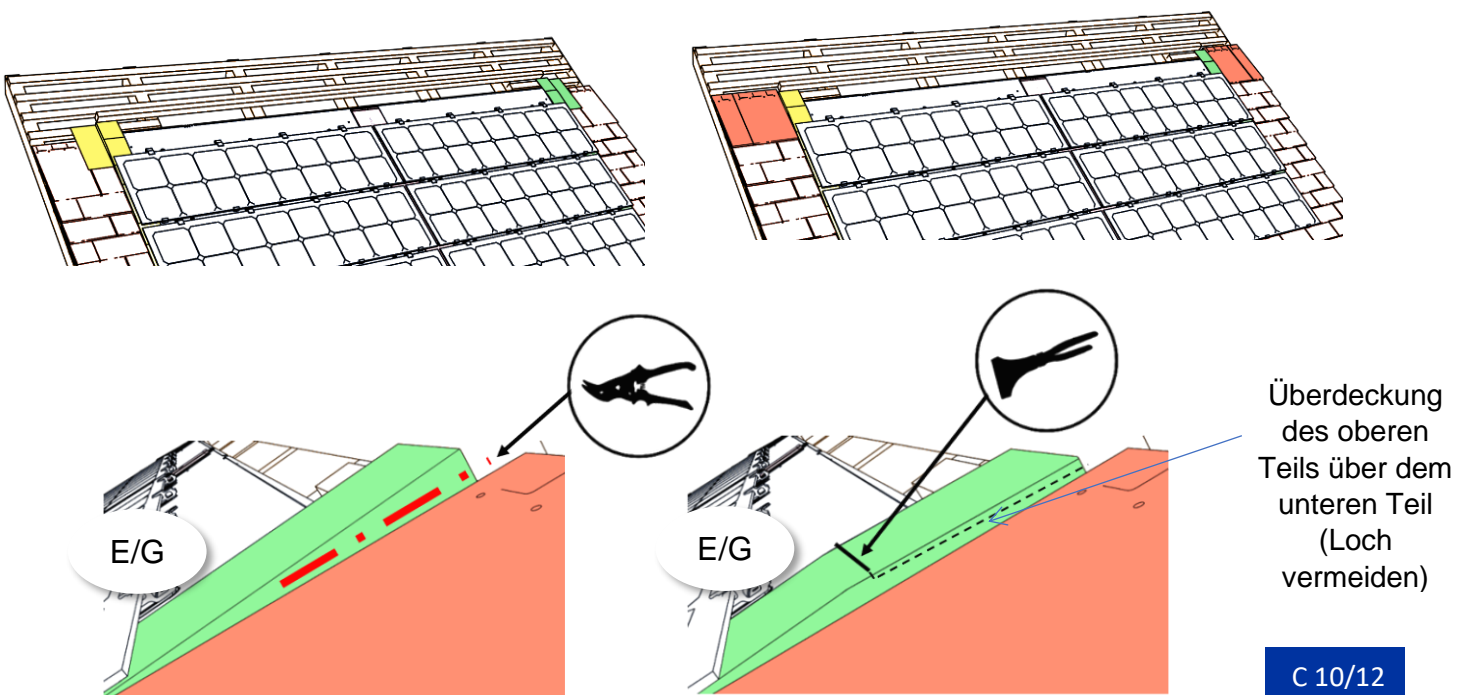

9. OBERE ABWEISERBLECHE VERLEGEN

UND ZIEGEL ÜBER DEM SOLARBEREICH VERLEGEN

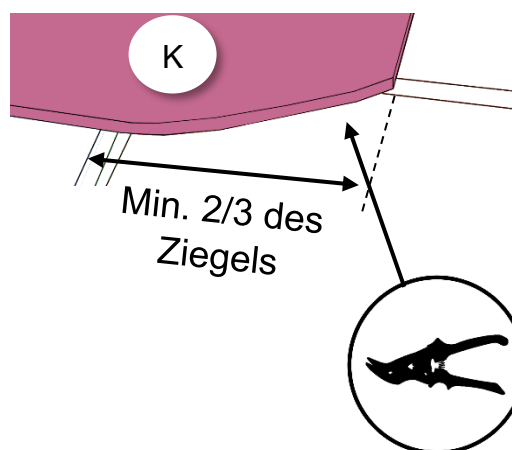
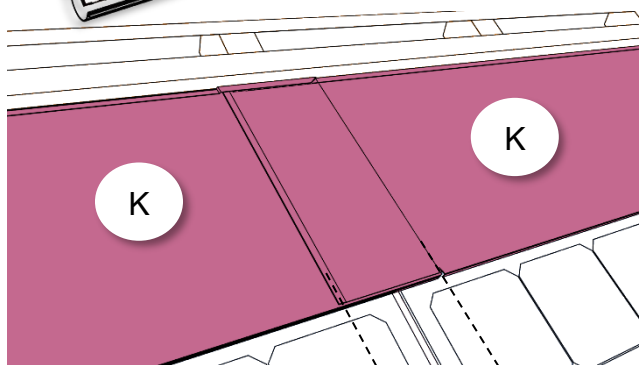
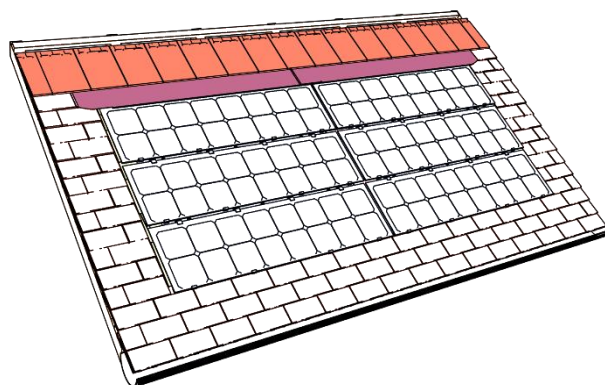
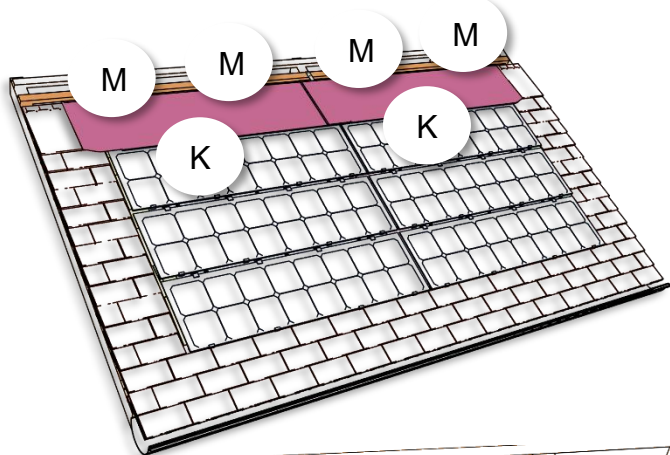

120 mm
2 x 4,5*30 mm

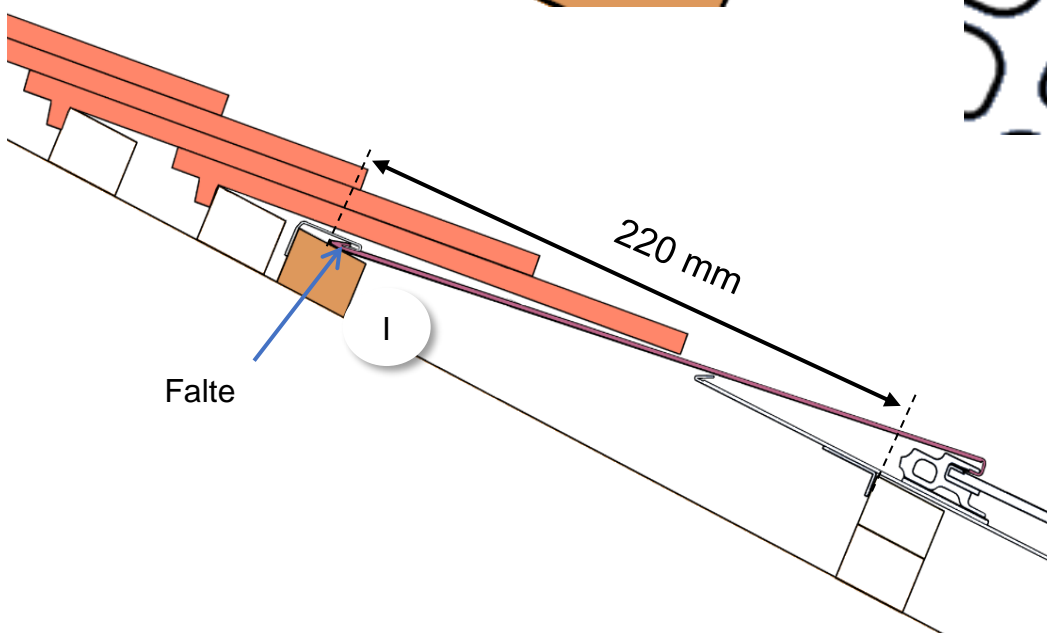
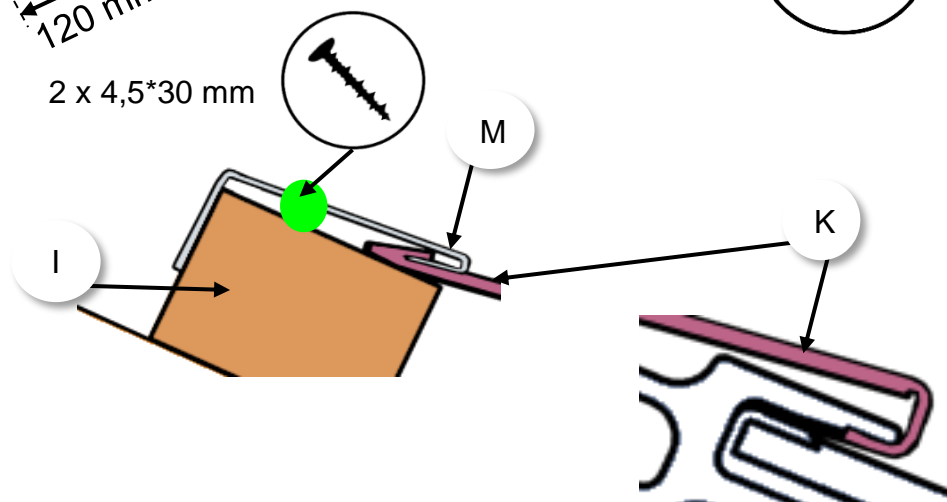

10. DACHZIEGEL UM DEN SOLARBEREICH HERUM BEFESTIGEN

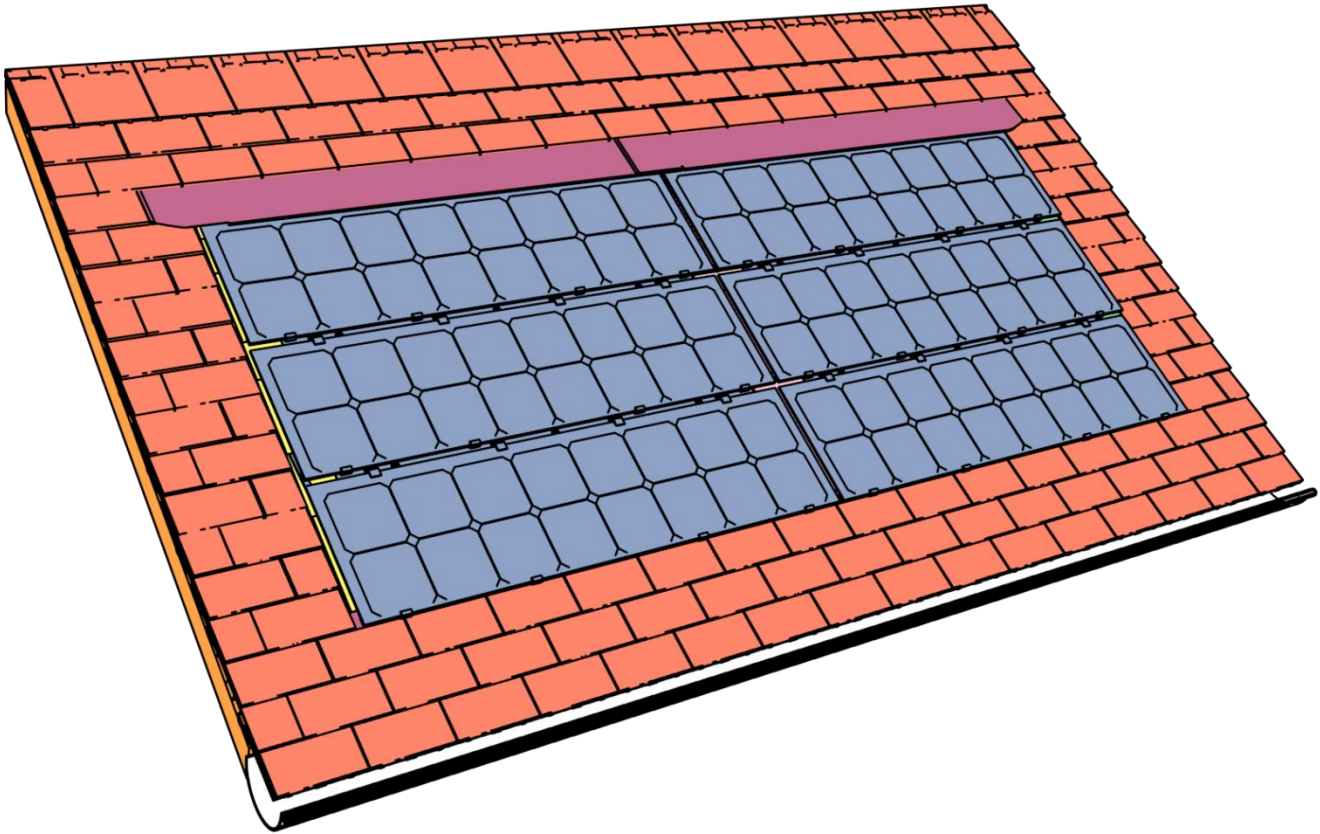
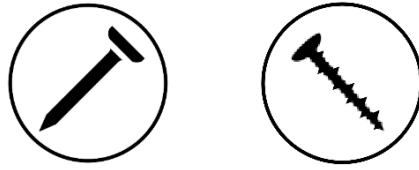

EDILIANS, Standort ARNAS
3, Impasse de Chavanne
F-69400 ARNAS
Hotline: 0810 148 223
E-Mail: be.solaire@edilians.com



Dieses Dokument darf ohne schriftliche Genehmigung von EDILIANS weder vervielfältigt noch weitergegeben werden. - Keine der Illustrationen kann einen verbindlichen